

## **Package leaflet: Information for the user**

### **Prolia 60 mg solution for injection in pre-filled syringe** denosumab

**Read all of this leaflet carefully before you start using this medicine because it contains important information for you.**

- Keep this leaflet. You may need to read it again.
- If you have any further questions, ask your doctor or pharmacist.
- This medicine has been prescribed for you only. Do not pass it on to others. It may harm them, even if their signs of illness are the same as yours.
- If you get any side effects, talk to your doctor or pharmacist. This includes any possible side effects not listed in this leaflet. See section 4.
- Your doctor will give you a patient reminder card, which contains important safety information you need to be aware of before and during your treatment with Prolia.

#### **What is in this leaflet**

1. What Prolia is and what it is used for
2. What you need to know before you use Prolia
3. How to use Prolia
4. Possible side effects
5. How to store Prolia
6. Contents of the pack and other information

#### **1. What Prolia is and what it is used for**

##### **What Prolia is and how it works**

Prolia contains denosumab, a protein (monoclonal antibody) that interferes with the action of another protein, in order to treat bone loss and osteoporosis. Treatment with Prolia makes bone stronger and less likely to break.

Bone is a living tissue and is renewed all the time. Oestrogen helps keep bones healthy. After the menopause, oestrogen level drops which may cause bones to become thin and fragile. This can eventually lead to a condition called osteoporosis. Osteoporosis can also occur in men due to a number of causes including ageing and/or a low level of the male hormone, testosterone. It can also occur in patients receiving glucocorticoids. Many patients with osteoporosis have no symptoms, but they are still at risk of breaking bones, especially in the spine, hips and wrists.

Surgery or medicines that stop the production of oestrogen or testosterone used to treat patients with breast or prostate cancer can also lead to bone loss. The bones become weaker and break more easily.

##### **What Prolia is used for**

Prolia is used to treat:

- osteoporosis in women after the menopause (postmenopausal) and men who have an increased risk of fracture (broken bones), reducing the risk of spinal, non-spinal and hip fractures.
- bone loss that results from a reduction in hormone (testosterone) level caused by surgery or treatment with medicines in patients with prostate cancer.
- bone loss that results from long-term treatment with glucocorticoids in patients who have an increased risk of fracture.

## 2. What you need to know before you use Prolia

### Do not use Prolia

- if you have low calcium levels in the blood (hypocalcaemia).
- if you are allergic to denosumab or any of the other ingredients of this medicine (listed in section 6).

### Warnings and precautions

Talk to your doctor or pharmacist before using Prolia

Whilst being treated with Prolia you may develop a skin infection with symptoms such as a swollen, red area of skin, most commonly in the lower leg, that feels hot and tender (cellulitis), and possibly with symptoms of fever. Please tell your doctor immediately if you develop any of these symptoms.

Please tell your doctor if you have an allergy to latex (the needle cover on the pre-filled syringe contains a derivative of latex).

You should also take calcium and vitamin D supplements while being on treatment with Prolia. Your doctor will discuss this with you.

You may have low levels of calcium in your blood while receiving Prolia. Please tell your doctor immediately if you notice any of the following symptoms: spasms, twitches, or cramps in your muscle, and/or numbness or tingling in your fingers, toes or around your mouth, and/or seizures, confusion, or loss of consciousness.

Tell your doctor if you have or have ever had severe kidney problems, kidney failure or have needed dialysis or are taking medicines called glucocorticoids (such as prednisolone or dexamethasone), which may increase your risk of getting low blood calcium if you do not take calcium supplements.

#### Problems with your mouth, teeth or jaw

A side effect called osteonecrosis of the jaw (ONJ) (bone damage in the jaw) has been reported rarely (may affect up to 1 in 1,000 people) in patients receiving Prolia for osteoporosis. The risk of ONJ increases in patients treated for a long time (may affect up to 1 in 200 people if treated for 10 years). ONJ can also occur after stopping treatment. It is important to try to prevent ONJ developing as it may be a painful condition that can be difficult to treat. In order to reduce the risk of developing ONJ, take the following precautions:

Before receiving treatment, tell your doctor or nurse (health care professional) if you:

- have any problems with your mouth or teeth such as poor dental health, gum disease, or a planned tooth extraction.
- don't receive routine dental care or have not had a dental check-up for a long time.
- are a smoker (as this may increase the risk of dental problems).
- have previously been treated with a bisphosphonate (used to treat or prevent bone disorders).
- are taking medicines called corticosteroids (such as prednisolone or dexamethasone).
- have cancer.

Your doctor may ask you to undergo a dental examination before you start treatment with Prolia.

While being treated, you should maintain good oral hygiene and receive routine dental check-ups. If you wear dentures you should make sure these fit properly. If you are under dental treatment or will undergo dental surgery (e.g. tooth extractions), inform your doctor about your dental treatment and tell your dentist that you are being treated with Prolia.

Contact your doctor and dentist immediately if you experience any problems with your mouth or teeth such as loose teeth, pain or swelling, or non-healing of sores or discharge, as these could be signs of ONJ.

#### Unusual thigh bone fractures

Some people have developed unusual fractures in their thigh bone while being treated with Prolia. Contact your doctor if you experience new or unusual pain in your hip, groin, or thigh.

#### **Children and adolescents**

Prolia is not recommended for children and adolescents under 18 years of age. The use of Prolia in children and adolescents has not been studied.

#### **Other medicines and Prolia**

Tell your doctor or pharmacist if you are taking, have recently taken or might take any other medicines. It is especially important that you tell your doctor if you are being treated with another medicine containing denosumab.

You should not take Prolia together with another medicine containing denosumab.

#### **Pregnancy and breast-feeding**

Prolia has not been tested in pregnant women. It is important to tell your doctor if you are pregnant; think you may be pregnant; or plan to get pregnant. Prolia is not recommended for use if you are pregnant. Women of child-bearing potential should use effective methods of contraception while being treated with Prolia and for at least 5 months after stopping treatment with Prolia.

If you become pregnant during treatment with Prolia or less than 5 months after stopping treatment with Prolia, please inform your doctor.

It is not known whether Prolia is excreted in breast milk. It is important to tell your doctor if you are breast-feeding or plan to do so. Your doctor will then help you decide whether to stop breast-feeding, or whether to stop taking Prolia, considering the benefit of breast-feeding to the baby and the benefit of Prolia to the mother.

If you are breast-feeding during Prolia treatment, please inform your doctor.

Ask your doctor or pharmacist for advice before taking any medicine.

#### **Driving and using machines**

Prolia has no or negligible influence on the ability to drive and use machines.

#### **Prolia contains sorbitol**

This medicine contains 47 mg sorbitol in each mL of solution.

#### **Prolia contains sodium**

This medicine contains less than 1 mmol sodium (23 mg) per 60 mg, that is to say essentially 'sodium-free'.

### 3. How to use Prolia

The recommended dose is one pre-filled syringe of 60 mg administered once every 6 months, as a single injection under the skin (subcutaneous). The best places to inject are the top of your thighs and the abdomen. Your carer can also use the outer area of your upper arm. Each pack of Prolia contains a reminder card with stickers that can be removed from the carton. Use the peel-off stickers to mark the next injection date on your personal calendar and/or the reminder card to keep a record of the next injection date.

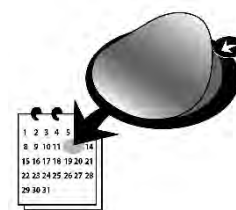

You should also take calcium and vitamin D supplements while being on treatment with Prolia. Your doctor will discuss this with you.

Your doctor may decide that it is best for you or a carer to inject Prolia. Your doctor or healthcare provider will show you or your carer how to use Prolia. For instructions on how to inject Prolia, please read the section at the end of this leaflet.

Do not shake.

#### If you forget to use Prolia

If a dose of Prolia is missed, the injection should be administered as soon as possible. Thereafter, injections should be scheduled every 6 months from the date of the last injection.

#### If you stop using Prolia

To get the most benefit from your treatment, it is important to use Prolia for as long as your doctor prescribes it for you. Please talk to your doctor before you consider stopping the treatment.

### 4. Possible side effects

Like all medicines, this medicine can cause side effects, although not everybody gets them.

Uncommonly, patients receiving Prolia may develop skin infections (predominantly cellulitis). **Please tell your doctor immediately** if you develop any of these symptoms while being on treatment with Prolia: swollen, red area of skin, most commonly in the lower leg, that feels hot and tender, and possibly with symptoms of fever.

Rarely, patients receiving Prolia may develop pain in the mouth and/or jaw, swelling or non-healing of sores in the mouth or jaw, discharge, numbness or a feeling of heaviness in the jaw, or loosening of a tooth. These could be signs of bone damage in the jaw (osteonecrosis). **Tell your doctor and dentist immediately** if you experience such symptoms while being treated with Prolia or after stopping treatment.

Rarely, patients receiving Prolia may have low calcium levels in the blood (hypocalcaemia). Symptoms include spasms, twitches, or cramps in your muscles, and/or numbness or tingling in your fingers, toes or around your mouth and/or seizures, confusion, or loss of consciousness. If any of these apply to you, **tell your doctor immediately**. Low calcium in the blood may also lead to a change in heart rhythm called QT prolongation which is seen by electrocardiogram (ECG).

Rarely unusual fractures of the thigh bone may occur in patients receiving Prolia. **Contact your doctor** if you experience new or unusual pain in your hip, groin or thigh as this may be an early indication of a possible fracture of the thigh bone.

Rarely, allergic reactions may occur in patients receiving Prolia. Symptoms include swelling of the face, lips, tongue, throat or other parts of the body; rash, itching or hives on the skin, wheezing or difficulty breathing. **Please tell your doctor** if you develop any of these symptoms while being treated with Prolia.

**Very common side effects** (may affect more than 1 in 10 people):

- bone, joint, and/or muscle pain which is sometimes severe,
- arm or leg pain (pain in extremity).

**Common side effects** (may affect up to 1 in 10 people):

- painful urination, frequent urination, blood in the urine, inability to hold your urine,
- upper respiratory tract infection,
- pain, tingling or numbness that moves down your leg (sciatica),
- constipation,
- abdominal discomfort,
- rash,
- skin condition with itching, redness and/or dryness (eczema),
- hair loss (alopecia).

**Uncommon side effects** (may affect up to 1 in 100 people):

- fever, vomiting and abdominal pain or discomfort (diverticulitis),
- ear infection,
- rash that may occur on the skin or sores in the mouth (lichenoid drug eruptions).

**Not known** (frequency cannot be estimated from the available data):

- Talk to your doctor if you have ear pain, discharge from the ear and/or an ear infection. These could be signs of bone damage in the ear.

### **Reporting of side effects**

If you get any side effects, talk to your doctor or pharmacist. This includes any possible side effects not listed in this leaflet. You can also report side effects directly (see details below). By reporting side effects you can help provide more information on the safety of this medicine.

#### **United Kingdom**

Yellow Card Scheme

Website: [www.mhra.gov.uk/yellowcard](http://www.mhra.gov.uk/yellowcard) or search for MHRA Yellow Card in the Google Play or Apple App Store

#### **Ireland**

HPRA Pharmacovigilance

Website: [www.hpra.ie](http://www.hpra.ie)

#### **Malta**

ADR Reporting

Website: [www.medicinesauthority.gov.mt/adrportal](http://www.medicinesauthority.gov.mt/adrportal)

The Medicines Authority

Post-Licensing Directorate

203 Level 3, Rue D'Argens

GŻR-1368 Gżira

Website: [www.medicinesauthority.gov.mt](http://www.medicinesauthority.gov.mt)

e-mail: [postlicensing.medicinesauthority@gov.mt](mailto:postlicensing.medicinesauthority@gov.mt)

## 5. How to store Prolia

Keep this medicine out of the sight and reach of children.

Do not use this medicine after the expiry date which is stated on the label and carton after EXP. The expiry date refers to the last day of that month.

Store in a refrigerator (2°C – 8°C).

Do not freeze.

Keep the container in the outer carton in order to protect from light.

Your pre-filled syringe may be left outside the refrigerator to reach room temperature (up to 25°C) before injection. This will make the injection more comfortable. Once your syringe has been left to reach room temperature (up to 25°C), it must be used within 30 days.

Do not throw away any medicines via wastewater or household waste. Ask your pharmacist how to throw away medicines you no longer use. These measures will help to protect the environment.

## 6. Contents of the pack and other information

### What Prolia contains

- The active substance is denosumab. Each 1 mL pre-filled syringe contains 60 mg of denosumab (60 mg/mL).
- The other ingredients are acetic acid, glacial, sodium hydroxide, sorbitol (E420), polysorbate 20 and water for injections.

### What Prolia looks like and contents of the pack

Prolia is a clear, colourless to slightly yellow solution for injection provided in a ready to use pre-filled syringe.

Each pack contains one pre-filled syringe with a needle guard.

Each pack contains one pre-filled syringe.

Not all pack sizes may be marketed.

### Marketing Authorisation Holder and Manufacturer

Amgen Europe B.V.

Minervum 7061,

4817 ZK Breda,

The Netherlands

### Marketing Authorisation Holder

Amgen Europe B.V.

Minervum 7061

4817 ZK Breda

The Netherlands

**Manufacturer**

Amgen Technology (Ireland) Unlimited Company  
Pottery Road  
Dun Laoghaire  
Co Dublin  
Ireland

**Manufacturer**

Amgen NV  
Telecomlaan 5-7  
1831 Diegem  
Belgium

For any information about this medicine, please contact the local representative of the Marketing Authorisation Holder.

**United Kingdom**

Amgen Limited  
Tel: +44 (0)1223 420305

**Ireland**

Amgen Ireland Limited  
Tel: +353 1 8527400

**Malta**

Amgen B.V.  
The Netherlands  
Tel: +31 (0)76 5732500

**This leaflet was last revised in January 2020.**

**Other sources of information**

Detailed information on this medicine is available on the European Medicines Agency web site:  
<http://www.ema.europa.eu/>

---

Instructions for use:

Guide to parts

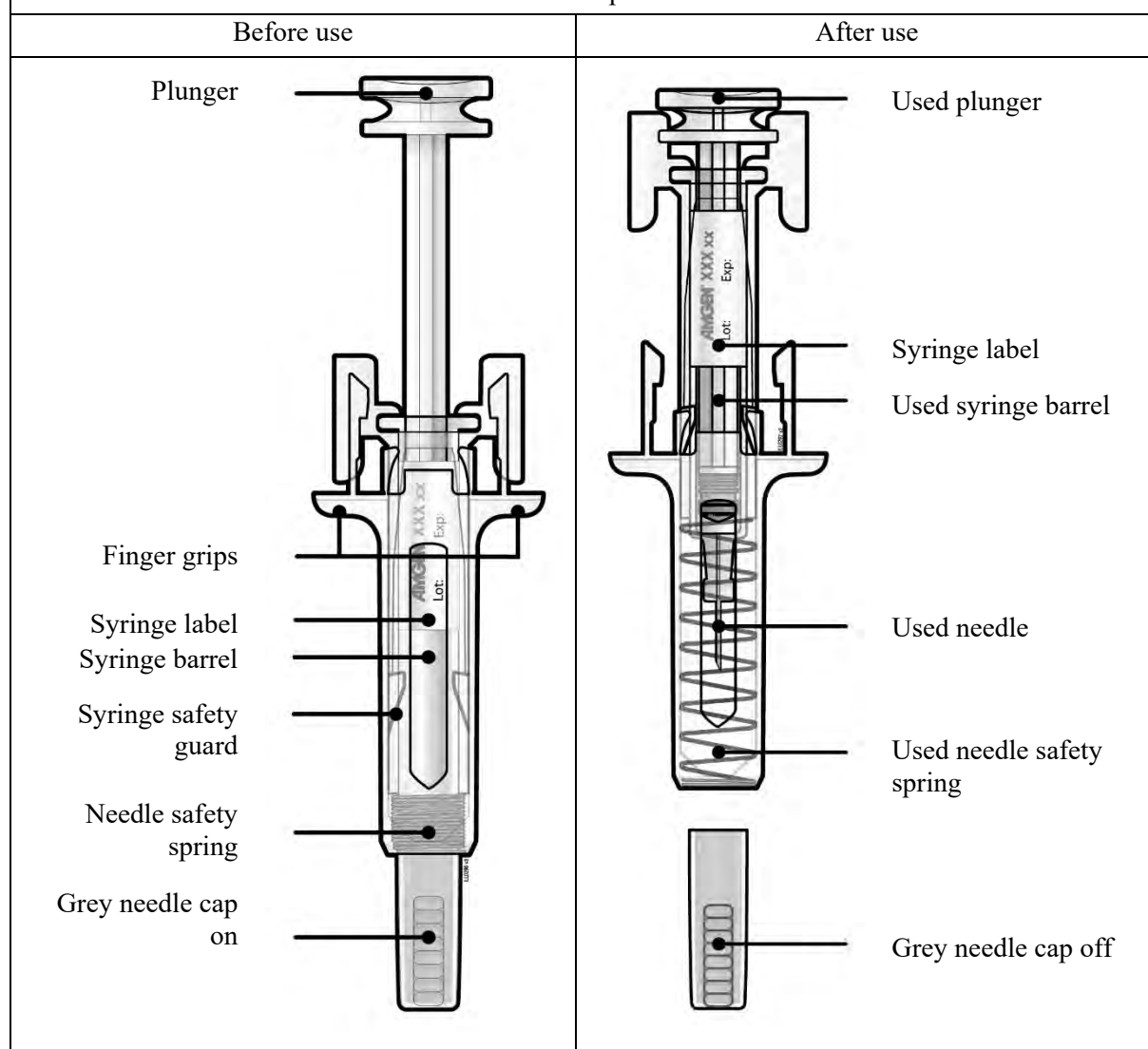

**Important**

**Before you use a Prolia pre-filled syringe with automatic needle guard, read this important information:**

- It is important that you do not try to give yourself the injection unless you have received training from your doctor or healthcare provider.
- Prolia is given as an injection into the tissue just under the skin (subcutaneous injection).
- Tell your doctor if you have an allergy to latex (the needle cap on the pre-filled syringe contains a derivative of latex).
- ✗ **Do not** remove the grey needle cap from the pre-filled syringe until you are ready to inject.
- ✗ **Do not** use the pre-filled syringe if it has been dropped on a hard surface. Use a new pre-filled syringe and call your doctor or healthcare provider.
- ✗ **Do not** attempt to activate the pre-filled syringe prior to injection.
- ✗ **Do not** attempt to remove the clear pre-filled syringe safety guard from the pre-filled syringe.

Call your doctor or healthcare provider if you have any questions.



**Step 1: Prepare**

**A** Remove the pre-filled syringe tray from the package and gather the supplies needed for your injection: alcohol wipes, a cotton ball or gauze pad, a plaster and a sharps disposal container (not included).

For a more comfortable injection, leave the pre-filled syringe at room temperature for about 30 minutes before injecting. Wash your hands thoroughly with soap and water.

On a clean, well-lit work surface, place the new pre-filled syringe and the other supplies.

- ✗ **Do not** try to warm the syringe by using a heat source such as hot water or microwave.
- ✗ **Do not** leave the pre-filled syringe exposed to direct sunlight.
- ✗ **Do not** shake the pre-filled syringe.
- **Keep the pre-filled syringe out of the sight and reach of children.**

**B** Open the tray, peeling away the cover. Grab the pre-filled syringe safety guard to remove the pre-filled syringe from the tray.

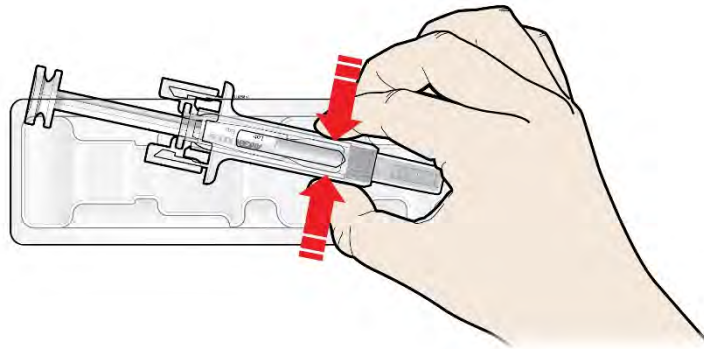

**Grab here**

For safety reasons:

- ✗ **Do not** grasp the plunger.
- ✗ **Do not** grasp the grey needle cap.

**C** Inspect the medicine and pre-filled syringe.

Medicine

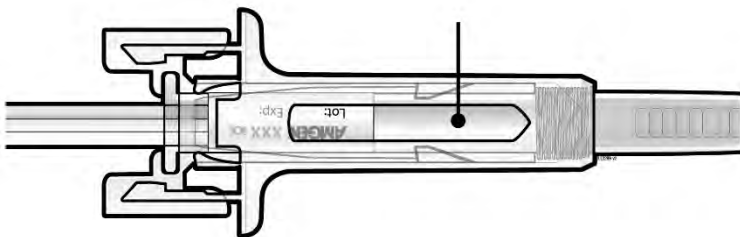

- ✗ **Do not** use the pre-filled syringe if:
  - The medicine is cloudy or there are particles in it. It must be a clear, colourless to slightly yellow solution.
  - Any part appears cracked or broken.
  - The grey needle cap is missing or not securely attached.
  - The expiry date printed on the label has passed the last day of the month shown.

In all cases, call your doctor or healthcare provider.

Step 2: **Get ready**

A Wash your hands thoroughly. Prepare and clean your injection site.

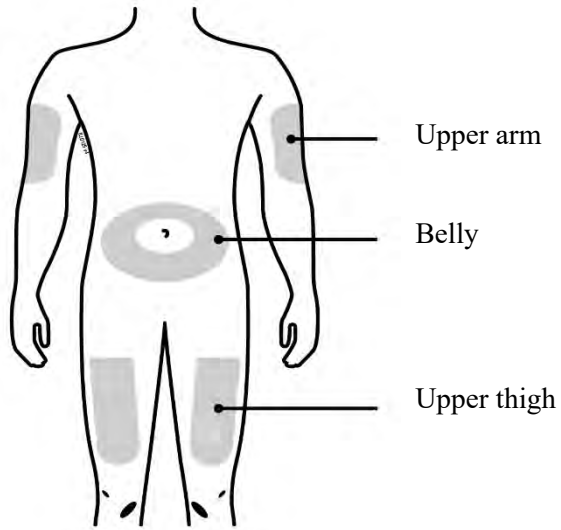

**You can use:**

- Upper part of your thigh.
- Belly, except for a 5 cm (2-inch) area right around your belly button.
- Outer area of upper arm (only if someone else is giving you the injection).

Clean the injection site with an alcohol wipe. Let your skin dry.

✘ **Do not** touch the injection site before injecting.



**Do not** inject into areas where the skin is tender, bruised, red, or hard. Avoid injecting into areas with scars or stretch marks.

B Carefully pull the grey needle cap straight out and away from your body.

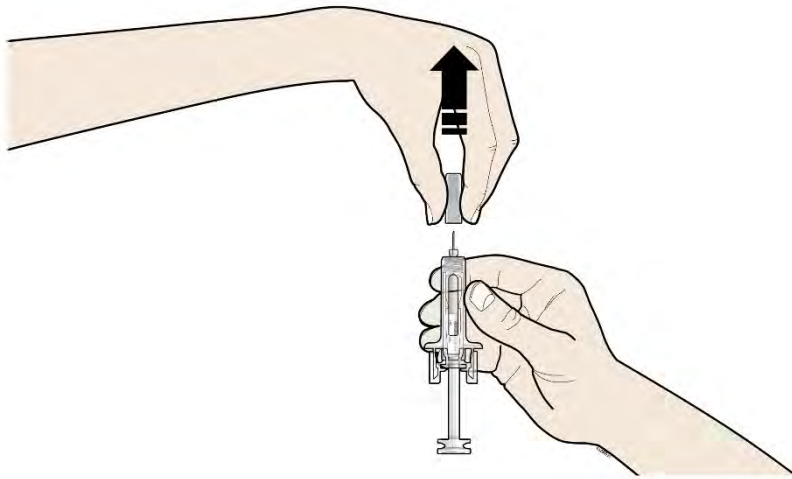

C Pinch your injection site to create a firm surface.

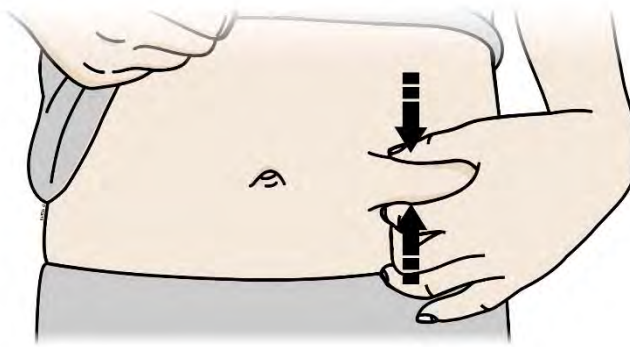

It is important to keep the skin pinched when injecting.

**Step 3: Inject**

A Hold the pinch. INSERT the needle into skin.

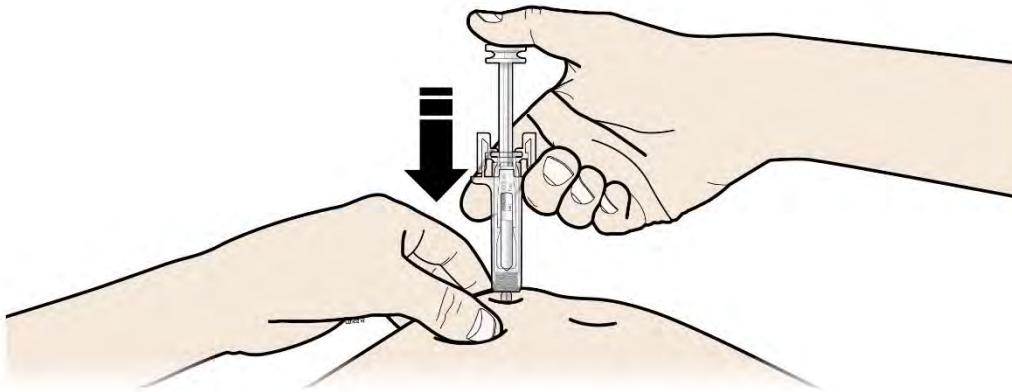

**x Do not touch the cleaned area of the skin.**

B PUSH the plunger with slow and constant pressure until you feel or hear a “snap”. Push all the way down through the snap.

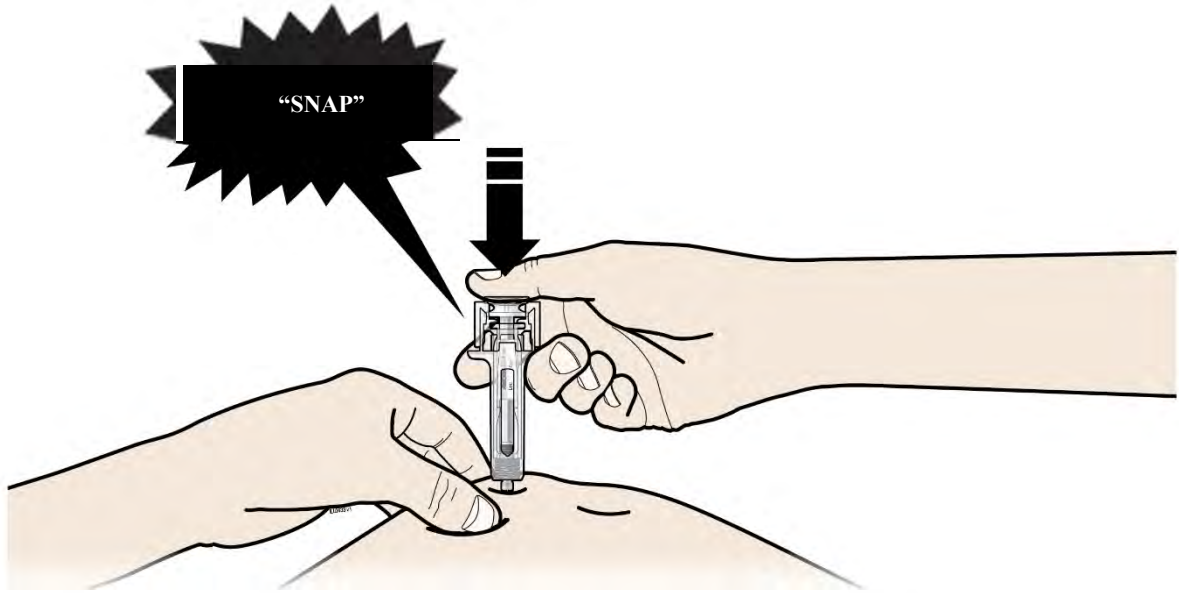

It is important to push down through the “snap” to deliver your full dose.

C RELEASE your thumb. Then LIFT the syringe off skin.

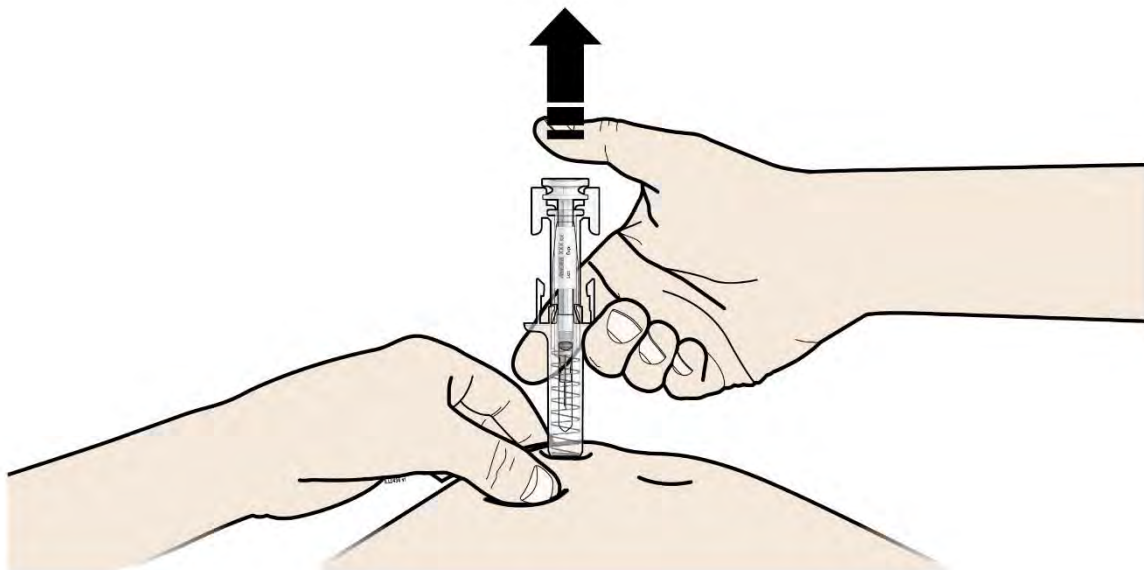

After releasing the plunger, the pre-filled syringe safety guard will safely cover the injection needle.

**x Do not** put the grey needle cap back on used pre-filled syringes.

Step 4: **Finish**

A Discard the used pre-filled syringe and other supplies in a sharps disposal container.

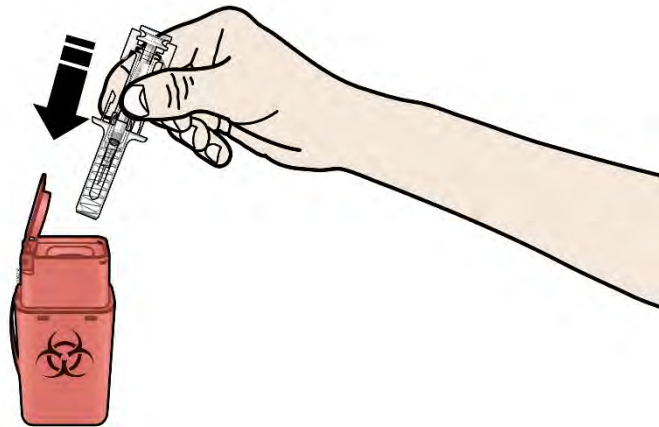

Medicines should be disposed of in accordance with local requirements. Ask your pharmacist how to dispose of medicines no longer required. These measures will help to protect the environment.

Keep the syringe and sharps disposal container out of sight and reach of children.

✘ **Do not** reuse the pre-filled syringe.

✘ **Do not** recycle pre-filled syringes or throw them into household waste.

B Examine the injection site.

If there is blood, press a cotton ball or gauze pad on your injection site. **Do not** rub the injection site. Apply a plaster if needed.

## Instructions for injecting with the Prolia pre-filled syringe

This section contains information on how to use the Prolia pre-filled syringe. **It is important that you or your carer do not give the injection unless training from your doctor or healthcare provider has been received.** Always wash your hands before every injection. If you have questions about how to inject, please ask your doctor or healthcare provider for assistance.

### Before you begin

**Read all instructions thoroughly before using the pre-filled syringe.**

**DO NOT** use the pre-filled syringe if the needle cover has been removed.

### How do you use the Prolia pre-filled syringe?

Your doctor has prescribed a Prolia pre-filled syringe for injection into the tissue just under the skin (subcutaneous). You must inject the entire content (1 mL) of the Prolia pre-filled syringe and it should be injected once every 6 months as instructed by your doctor.

### Equipment:

To give an injection, you will need:

1. A new Prolia pre-filled syringe
2. Alcohol wipes or similar.

### What to do before you give a subcutaneous injection of Prolia

1. Remove the pre-filled syringe from the refrigerator.  
**DO NOT** pick up the pre-filled syringe by the plunger or needle cover. This could damage the device.
2. The pre-filled syringe may be left outside the refrigerator to reach room temperature. This will make the injection more comfortable.  
**DO NOT** warm it in any other way, for example, in a microwave or in hot water.  
**DO NOT** leave the syringe exposed to direct sunlight.
3. **DO NOT** shake the pre-filled syringe.
4. **DO NOT** remove the needle cover from the pre-filled syringe until you are ready to inject.
5. Check the expiry date on the pre-filled syringe label (EXP).  
**DO NOT** use it if the date has passed the last day of the month shown.
6. Check the appearance of Prolia. It must be a clear, colourless to slightly yellow solution. The solution should not be injected if it contains particles or if it is discoloured or cloudy.
7. Find a comfortable, well-lit, clean surface and put all the equipment within reach.
8. Wash your hands thoroughly.

### Where should you give the injection?

The best places to inject are the top of your thighs and the abdomen.

Your carer can also use the outer area of your upper arms.

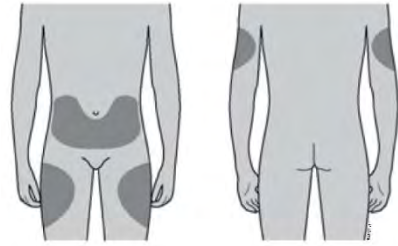

### How do you give the injection?

1. Disinfect the skin by using an alcohol wipe.
2. To avoid bending the needle, gently pull the cover from the needle straight off without twisting, as shown in pictures 1 and 2.  
**DO NOT** touch the needle or push the plunger.
3. You may notice a small air bubble in the pre-filled syringe. You do not have to remove the air bubble before injecting. Injecting the solution with the air bubble is harmless.
4. Pinch (without squeezing) the skin between your thumb and forefinger. Put the needle fully into the skin as shown by your doctor or healthcare provider.
5. Push the plunger with a **slow** constant pressure, always keeping the skin pinched. Push the plunger all the way down as far as it will go to inject **all the solution**.
6. Remove the needle and let go of the skin.
7. If you notice a spot of blood you may gently dab it away with a cotton ball or tissue. Do not rub the injection site. If needed, you may cover the injection site with a plaster.
8. Only use each pre-filled syringe for one injection. **DO NOT** use any Prolia that is left in the syringe.

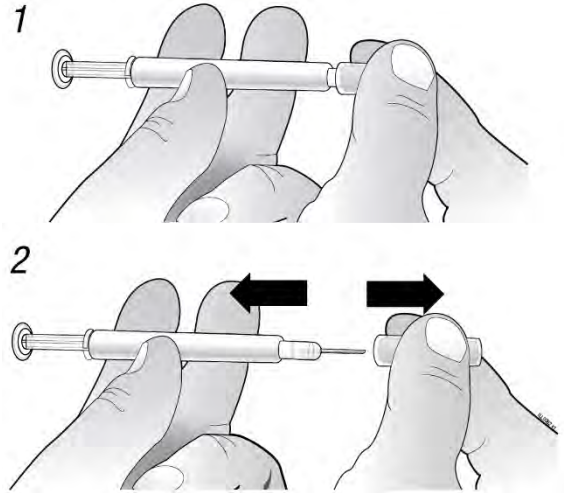

**Remember:** if you have any problems, please ask your doctor or healthcare provider for help and advice.

### Disposing of used syringes

- **DO NOT** put the cover back on used needles.
- Keep used syringes out of the reach and sight of children.
- The used syringe should be disposed of in accordance with local requirements. Ask your pharmacist how to dispose of medicines no longer required. These measures will help to protect the environment.